

# Fraïssé classes with simply characterized big Ramsey degrees

Natasha Dobrinen  
University of Denver

Midwest Model Theory Seminar – March 9, 2021

Joint work with Rebecca Coulson and Rehana Patel

Research supported by DMS-1901753



# Ramsey's Theorem

**Ramsey's Theorem.** Given any  $k, \ell \geq 1$  and a coloring on the collection of all  $k$ -element subsets of  $\omega$  into  $\ell$  colors, there is an infinite set  $M$  of natural numbers such that each  $k$ -element subset of  $M$  has the same color.

Ramsey's theorem can be thought of as a coloring theorem on a complete  $k$ -hypergraph on  $\omega$  many vertices.

## Ramsey theory on $(\mathbb{Q}, <)$

**Thm.** (Sierpiński) There is a coloring  $c : [\mathbb{Q}]^2 \rightarrow 2$  such that for each subset  $\mathbb{Q}' \subseteq \mathbb{Q}$  which forms a dense linear order without endpoints, both colors occur on  $[\mathbb{Q}']^2$ .

Sierpiński's coloring: Let  $\prec$  well-order  $\mathbb{Q}$  in order-type  $\omega$ . Given a pair  $\{p, q\} \in [\mathbb{Q}]^2$ , with  $p < q$ , define

$$c(\{p, q\}) = \begin{cases} 0 & \text{if } p \prec q \\ 1 & \text{if } q \prec p \end{cases}$$

**Thm.** (Galvin) Given any coloring of pairs of rationals into finitely many colors, there is a subset which is again a dense linear order in which at most two colors are used.

## Ramsey theory on $\mathbb{Q}$ , coded in $2^{<\omega}$

For  $s, t \in 2^{<\omega}$ , define  $s \triangleleft t$  iff one of the following holds:

- 1  $s <_{\text{lex}} t$ , or
- 2  $s \sqsubset t$  and  $t(|s|) = 1$ , or
- 3  $t \sqsubset s$  and  $s(|t|) = 0$ .

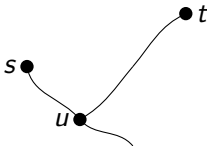

In this picture,  $s \triangleleft u \triangleleft t$ .

**Note:**  $(2^{<\omega}, \triangleleft) \cong (\mathbb{Q}, <)$ .

## Two types of antichains coding a pair of rationals

There is an antichain  $\mathbb{A} \subseteq 2^{<\omega}$  of nodes of different lengths such that  $(\mathbb{A}, \triangleleft) \cong (\mathbb{Q}, <)$ . Then in  $\mathbb{A}$ , there are two ways to represent an unordered pair of rationals: (draw)



# Sierpiński's and Galvin's results: Re-interpreted inside $2^{<\omega}$

- 1 Let  $c$  be a coloring of  $[\mathbb{Q}]^2$  into finitely many colors.
- 2 Transfer the coloring to pairs of nodes in  $2^{<\omega}$ .
- 3 Fix one similarity type. For each pair of nodes  $s, t$  of that type, color all 3-strong trees containing  $s$  and  $t$  with the color  $c(\{s, t\})$ .
- 4 Apply Milliken's Theorem to 3-strong trees. Get one color for all pairs with that similarity type.
- 5 Repeat for the second similarity type.
- 6 Take a diagonal antichain  $\mathbb{A} \subseteq 2^{<\omega}$  such that  $(\mathbb{A}, \triangleleft) \cong (\mathbb{Q}, <)$ .

( $\mathbb{A} \subseteq 2^{<\omega}$  is a diagonal antichain if any two nodes in the meet closure of  $\mathbb{A}$  have different lengths, and all nodes except splitting nodes extend left.)

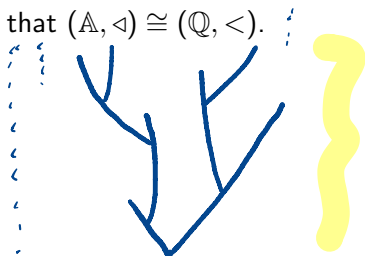

## $(\mathbb{Q}, <)$ has an approximate Infinite Ramsey Theorem

**Thm.** (Laver (upper bounds, unpub.), Devlin (exact bounds) 1979)

Given  $k \geq 2$ , there is a number  $T(k, \mathbb{Q})$  such that for each coloring of the  $k$ -element subsets of  $\mathbb{Q}$  into finitely many colors, there is a subcopy of  $\mathbb{Q}$  in which no more than  $T(k, \mathbb{Q})$  colors occur.

$T(k, \mathbb{Q})$  is the number of non-isomorphic diagonal antichains of size  $k$ .

These are actually **tangent numbers**.

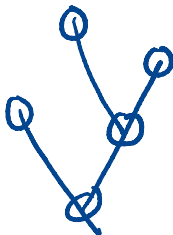

## $(\mathbb{Q}, <)$ has an approximate Infinite Ramsey Theorem

**Thm.** (Laver (upper bounds, unpub.), Devlin (exact bounds) 1979)

Given  $k \geq 2$ , there is a number  $T(k, \mathbb{Q})$  such that for each coloring of the  $k$ -element subsets of  $\mathbb{Q}$  into finitely many colors, there is a subcopy of  $\mathbb{Q}$  in which no more than  $T(k, \mathbb{Q})$  colors occur.

$T(k, \mathbb{Q})$  is the number of non-isomorphic diagonal antichains of size  $k$ .

These are actually **tangent numbers**.

So  $(\mathbb{Q}, <)$  does not have the exact analogue of Ramsey's Theorem for  $\mathbb{N}$ .

But  $(\mathbb{Q}, <)$  still behaves quite nicely in that finite bounds exist. These bounds  $T(k, \mathbb{Q})$  are called the **big Ramsey degrees of  $k$**  in  $\mathbb{Q}$ .



What about Ramsey theory on other infinite structures?

## Big Ramsey Degrees

Given an infinite structure  $\mathbf{S}$  and a finite substructure  $\mathbf{A} \leq \mathbf{S}$ , we let  $T(\mathbf{A}, \mathbf{S})$  denote the least  $T$  (if it exists) such that for any integer  $\ell \geq 1$ , given any coloring of  $\binom{\mathbf{S}}{\mathbf{A}}$  into  $\ell$  colors, there is a substructure  $\mathbf{S}'$  of  $\mathbf{S}$ , isomorphic to  $\mathbf{S}$ , such that  $\binom{\mathbf{S}'}{\mathbf{A}}$  takes no more than  $T$  colors.

When it exists,  $T(\mathbf{A}, \mathbf{S})$  is called the **big Ramsey degree** of  $\mathbf{A}$  in  $\mathbf{S}$ .

We say that  $\mathbf{S}$  has **finite big Ramsey degrees** if  $T(\mathbf{A}, \mathbf{S})$  exists for each finite substructure  $\mathbf{A} \leq \mathbf{S}$ .

This terminology was coined in [Kechris, Pestov, Todorcevic 2005].  
Motivation: Longstanding. More recent, [Zucker 2019].

## Big Ramsey Degrees: Brief History

- Infinite complete  $k$ -hypergraph: All BRD = 1. (Ramsey 1929)
- $T(2, \mathbb{Q}) \geq 2$  (Sierpiński 1933).  $T(2, \mathbb{Q}) = 2$  (Galvin unpub.)
- $T(\text{Edge}, \text{Rado}) \geq 2$  (Erdős, Hajnal, Pósa 1975)
- The rationals: BRD computed. (Devlin 1979)
- The  $K_3$ -free generic graph  $\mathcal{H}_3$ :  $T(1, \mathcal{H}_3) = 1$ . (Komjáth, Rödl 1986)
- The  $K_n$ -free generic graph  $\mathcal{H}_n$ :  $T(1, \mathcal{H}_n) = 1$ . (El-Zahar, Sauer 1989)
- $T(\text{Edge}, \text{Rado}) = 2$ . (Pouzet, Sauer 1996)
- $T(\text{Edge}, \mathcal{H}_3) = 2$  (Sauer 1998)
- The Rado graph, etc.: BRD characterized. (Laflamme, Sauer, Vuksanović 2006). BRD computed. (J. Larson 2008)
- The countable ultrametric Urysohn space: BRD computed. (Nguyen Van Thé 2008)
- $\mathbb{Q}_n$  and the directed graphs  $\mathbf{S}(2)$ ,  $\mathbf{S}(3)$ . BRD computed. (Laflamme, Nguyen Van Thé, Sauer 2010)

# Structures with finite big Ramsey degrees: Recent Work

- The  $k$ -clique-free generic graph  $\mathcal{H}_k$ : Finite BRD (Dobrinen 2020 and 2019\*)  
developed method of coding trees and related forcings
- 3-regular hypergraphs: Finite BRD (Balko, Chodounský, Hubička, Konečný, Vena 2019)  
developed a new Milliken-style theorem
- Universal structures, some metric spaces: Finite BRD (Mašulović 2020)  
used category theory
- $\mathbf{S}(n)$  for all  $n \geq 2$ : BRD calculated. (Barbosa 2020\*)  
used category theory

## Structures with finite big Ramsey degrees: Current Work

- Binary relational structures with free amalgamation, omitting finitely many irreducible substructures: Finite BRD (Zucker 2020\*)  
used coding trees and forcing, and developed abstract approach
- Partial order, metric spaces, etc.: Finite BRD. (Hubička 2020\*)  
used parameter words, first forcing-free proof for  $\mathcal{H}_3$
- Fraïssé structures with SDAP<sup>+</sup>: BRD characterized.  
(Coulson, Dobrinen, Patel 2020\*)  
develop coding trees of 1-types, first envelope-free proof
- Binary with finitely many forbidden irreducible substructures: BRD characterized.  
(Balko, Chodounsky, Dobrinen, Hubička, Konečný, Vena, Zucker 2021\*)  
various approaches

Other extensions in the works.

Fraïssé classes with simply characterized  
big Ramsey degrees

# Fraïssé Classes

A class  $\mathcal{K}$  of finite structures is a **Fraïssé class** if  $\mathcal{K}$  has the

- hereditary property
- joint embedding property
- amalgamation property

Given a Fraïssé class  $\mathcal{K}$ , there is a unique (up to isomorphism) countably infinite structure  $\mathbf{K} := \text{Flim}(\mathcal{K})$  which is ultrahomogeneous and universal for  $\mathcal{K}$ .

We will be working with Fraïssé classes with finitely many relations of any arity.

## Prototype Example: Finite linear orders

$\mathcal{LO}$ : Fraïssé class of finite linear orders. Fraïssé limit is  $(\mathbb{Q}, <)$ .

Devlin types for  $(\mathbb{Q}, <)$ . (draw)



## Second prototype example: Finite graphs

The Rado graph is the Fraïssé limit of the class of finite graphs.

Given a graph  $\mathbf{A}$  with vertices  $\langle v_n : n < N \rangle$ , a set of nodes  $\{t_n : n < N\} \subseteq 2^{<\omega}$  codes  $\mathbf{A}$  if and only if for each  $m < n < N$ ,  $v_n E v_m \Leftrightarrow t_n(|t_m|) = 1$ .  $t_n(|t_m|)$  is called the **passing number** of  $t_n$  at  $t_m$ .

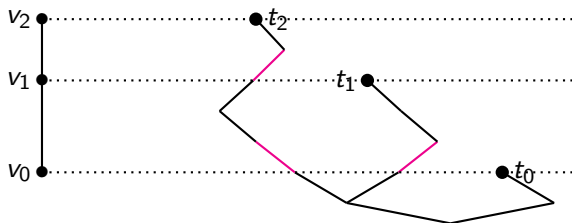

# Graphs have simply characterized big Ramsey degrees

Let  $\mathcal{G}$  be the Fraïssé class of finite graphs, and let  $\mathbf{R}$  denote its Fraïssé limit, the Rado graph.

**Theorem.** (Sauer 2006) and (Laflamme, Sauer, Vuksanovic 2006)  
The Fraïssé class of finite graphs has finite big Ramsey degrees in the Rado graph. Moreover, given  $\mathbf{A} \in \mathcal{G}$ ,  $T(\mathbf{A}, \mathbf{R})$  is the number of **similarity types of diagonal antichains** representing a copy of  $\mathbf{A}$ .



Proof uses  $2^{<\omega}$  to code a universal graph, Milliken's theorem on strong tree envelopes of diagonal antichains, and a diagonal antichain in  $2^{<\omega}$  coding the Rado graph.

## Similarity types for binary relational structures

Fix  $k \geq 2$ . An antichain  $A \subseteq k^{<\omega}$  is diagonal if the meet closure  $A^\wedge$  of  $A$  has splitting nodes with degree 2, the lengths among the splitting and terminal nodes are all distinct, and all passing numbers at splitting nodes are 0 (except for the right branch).

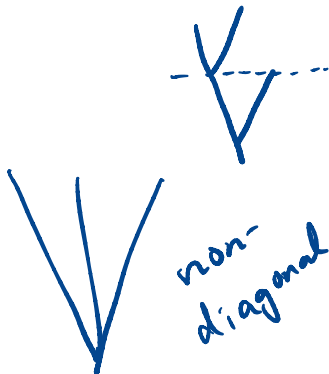
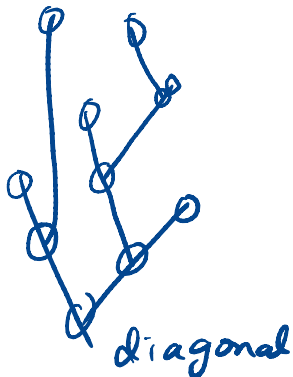

## Similarity types for binary relational structures

Fix  $k \geq 2$ . An antichain  $A \subseteq k^{<\omega}$  is **diagonal** if the meet closure  $A^\wedge$  of  $A$  has splitting nodes with degree 2, the lengths among the splitting and terminal nodes are all distinct, and all passing numbers at splitting nodes are 0 (except for the right branch).

Let  $A$  and  $B$  be antichains in  $k^{<\omega}$ . We say that  $A$  and  $B$  are **similar** ( $A \sim B$ ) iff there is a bijection  $f : A^\wedge \rightarrow B^\wedge$  satisfying the following:

- 1  $f$  preserves lexicographic order.
- 2  $f$  preserves meets.
- 3  $f$  preserves relative lengths.
- 4  $f$  preserves initial segments.
- 5  $f$  preserves passing numbers at terminal nodes.

A **similarity type** is a  $\sim$ -equivalence class.

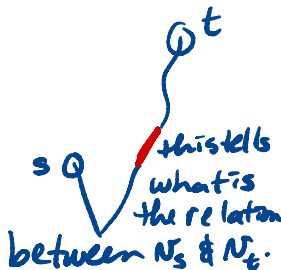

## Unrestricted binary relational Fraïssé classes

**Theorem.** (Laflamme, Sauer, Vuksanovic 2006)) Any Fraïssé class with finitely many binary relations and a universal constraint set has finite big Ramsey degrees characterized by similarity types of diagonal antichains.

(LSV) results apply to the Rado graph, generic ordered graph, generic tournament, random graphs with finitely many edge relations, etc.

Proof uses trees  $k^{<\omega}$ , for some finite  $k$ , which codes a universal structure into which the Fraïssé limit embeds, envelopes, Milliken's theorem, and a diagonal antichain coding the Fraïssé structure.

(CDP) extends (LSV), but with a more streamlined proof.

## Fraïssé classes with simply characterized BRD

Work by Coulson, D., and Patel was motivated by the following questions:

(Sauer, BIRS 2018) Can the forcing (done by D. for Henson graphs) be done directly on the Fraïssé structures?

(D.) For which Fraïssé classes can we prove finite big Ramsey degrees with reasonably simple forcing arguments (as compared with the Henson graphs)?

## Coding trees of 1-types

In (CDP), we move from trees on  $k^{<\omega}$  to trees of 1-types over initial structures of a fixed enumerated Fraïssé structure.

Let  $\mathbf{K}$  be the Fraïssé limit of a given Fraïssé class  $\mathcal{K}$  with enumerated vertices  $\langle v_n : n < \omega \rangle$ . Let  $\mathbf{K}_n$  denote  $\mathbf{K} \upharpoonright \{v_i : i < n\}$ .

The **coding tree of 1-types**  $\mathbb{S}(\mathbf{K})$  is the set of all complete quantifier-free 1-types over initial segments of  $\mathbf{K}$  along with a function  $c : \omega \rightarrow \mathbb{S}(\mathbf{K})$  such that  $c(n)$  is the 1-type of  $v_n$  over  $\mathbf{K}_n$ . The tree-ordering is simply inclusion.

Members of  $\mathbb{S}(\mathbf{K})$  can be thought of as sequences of partial 1-types:

$s(0)$  is the 1-type over the empty structure such that  $s(0) \subseteq s$ .

For  $1 \leq i \leq n$ ,  $s(i)$  is the set of formulas in  $s \upharpoonright \mathbf{K}_i$  that are not in  $s \upharpoonright \mathbf{K}_{i-1}$ .

Each  $s \in \mathbb{S}(\mathbf{K})$  determines a unique sequence  $\langle s(i) : i < |s| \rangle$ , where  $\{s(i) : i < |s|\}$  forms a partition of  $s$ .

# Coding Tree of 1-types for $(\mathbb{Q}, <)$

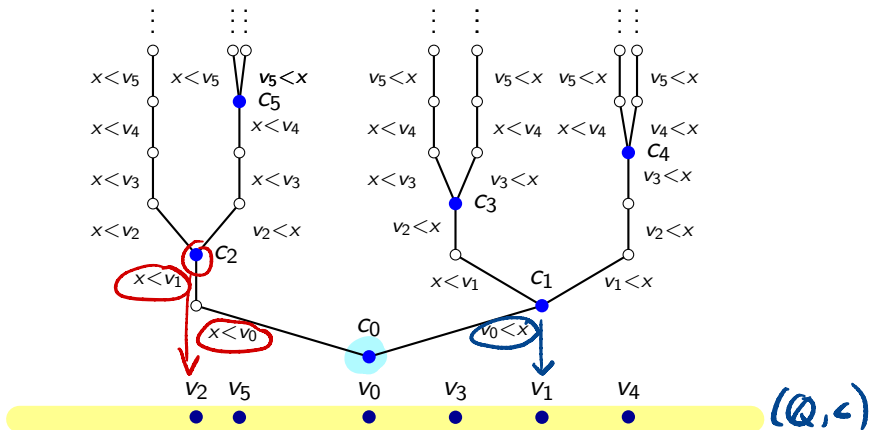

$$c_0 = \emptyset. \quad c_1 = \{(v_0 < x)\}. \quad c_2 = \{(x < v_0), (x < v_1)\}. \\ c_3 = \{(v_0 < x), (x < v_1), (v_2 < x)\}.$$



# Coding tree of 1-types for the generic bipartite graph

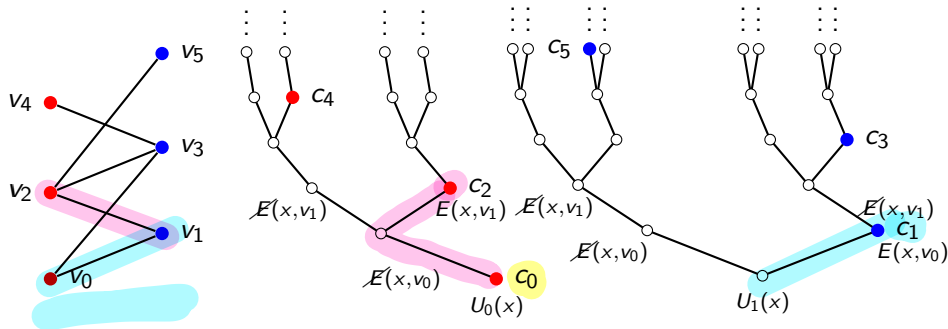

$$c_0 = \{U_0(x)\}. \quad c_1 = \{U_1(x), E(x, v_0)\}.$$

$$c_2 = \{U_0(x), \neg E(x, v_0), E(x, v_1)\}.$$

$$c_3 = \{U_1(x), E(x, v_0), \neg E(x, v_1), E(x, v_2)\}.$$

# Coding tree of 1-types for the generic 3-regular hypergraph

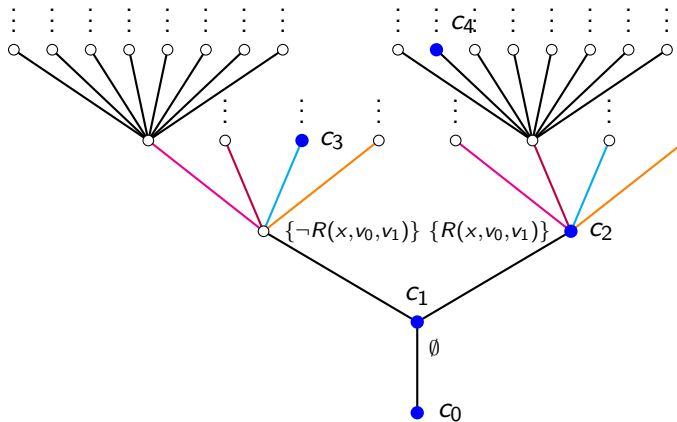
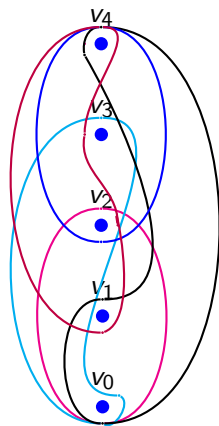

$$c_2 = \{R(x, v_0, v_1)\}. \quad c_3 = \{\neg R(x, v_0, v_1), R(x, v_0, v_2), \neg R(x, v_1, v_2)\}.$$

# Coding tree of 1-types for $\mathbb{Q}_Q$

$\mathcal{L} = \{<, E\}$ , where  $<$  is a linear order, and  $E$  is an equivalence relation with convex equivalence classes.

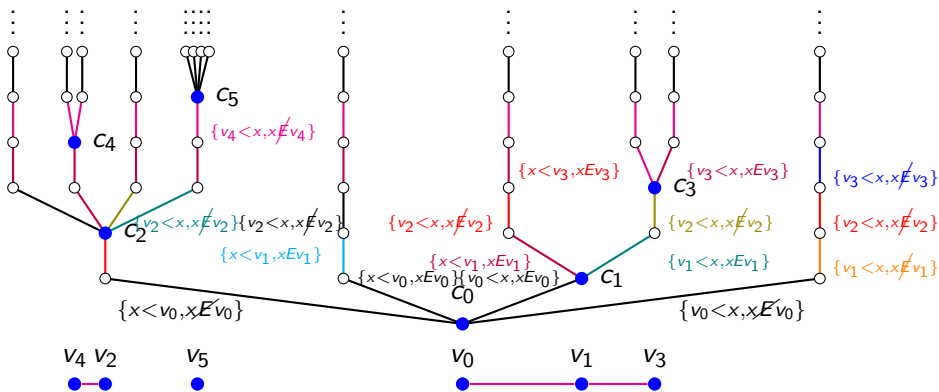

$$c_0 = \emptyset. \quad c_1 = \{v_0 < x, x \notin E v_0\}. \quad c_2 = \{x < v_0, x \notin E v_0, x < v_1, x \notin E v_1\}.$$

# Substructure Free Amalgamation Property

A Fraïssé class  $\mathcal{K}$  satisfies **SFAP** if  $\mathcal{K}$  has free amalgamation, and given  $\mathbf{A}, \mathbf{B}, \mathbf{C}, \mathbf{D} \in \mathcal{K}$ , the following holds: Suppose

- (1)  $\mathbf{A}$  is a substructure of  $\mathbf{C}$ , where  $\mathbf{C}$  extends  $\mathbf{A}$  by two vertices, say  $C \setminus A = \{v, w\}$ ;
- (2)  $\mathbf{A}$  is a substructure of  $\mathbf{B}$  and  $\sigma$  and  $\tau$  are 1-types over  $\mathbf{B}$  with  $\sigma \upharpoonright \mathbf{A} = \text{tp}(v/\mathbf{A})$  and  $\tau \upharpoonright \mathbf{A} = \text{tp}(w/\mathbf{A})$ ; and
- (3)  $\mathbf{B}$  is a substructure of  $\mathbf{D}$  which extends  $\mathbf{B}$  by one vertex, say  $v'$ , such that  $\text{tp}(v'/\mathbf{B}) = \sigma$ .

Then there is an  $\mathbf{E} \in \mathcal{K}$  extending  $\mathbf{D}$  by one vertex, say  $w'$ , such that  $\text{tp}(w'/\mathbf{B}) = \tau$ ,  $\mathbf{E} \upharpoonright (A \cup \{v', w'\}) \cong \mathbf{C}$ , and  $\mathbf{E}$  adds no other relations over  $\mathbf{D}$ .

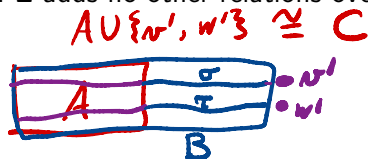
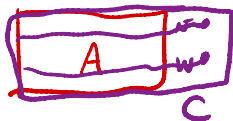

## SDAP<sup>+</sup>

$\mathcal{K}$  satisfies **SDAP** if  $\mathcal{K}$  has disjoint amalgamation, and given  $\mathbf{A}, \mathbf{C} \in \mathcal{K}$  with  $\mathbf{A}$  a substructure of  $\mathbf{C}$ , where  $C \setminus A = \{v, w\}$ , there exist  $\mathbf{A}', \mathbf{C}' \in \mathcal{K}$ , with  $\mathbf{A}$  a substructure of  $\mathbf{A}'$  and  $\mathbf{C}'$  a disjoint amalgamation of  $\mathbf{A}'$  and  $\mathbf{C}$  over  $\mathbf{A}$ , such that letting  $\{v', w'\} = C' \setminus A'$  and assuming

- (1)  $\mathbf{B} \in \mathcal{K}$  is any structure containing  $\mathbf{A}'$  as a substructure, and let  $\sigma$  and  $\tau$  be 1-types over  $\mathbf{B}$  satisfying  $\sigma \upharpoonright \mathbf{A}' = \text{tp}(v'/\mathbf{A}')$  and  $\tau \upharpoonright \mathbf{A}' = \text{tp}(w'/\mathbf{A}')$ ,
  - (2)  $\mathbf{D} \in \mathcal{K}$  extends  $\mathbf{B}$  by one vertex, say  $v''$ , such that  $\text{tp}(v''/\mathbf{B}) = \sigma$ ,
- Then there is an  $\mathbf{E} \in \mathcal{K}$  extending  $\mathbf{D}$  by one vertex, say  $w''$ , such that  $\text{tp}(w''/\mathbf{B}) = \tau$  and  $\mathbf{E} \upharpoonright (A \cup \{v'', w''\}) \cong \mathbf{C}$ .

## SDAP<sup>+</sup>:

**Prop.** SFAP implies SDAP<sup>+</sup>.

# Examples

The following Fraïssé classes satisfy SFAP:

- graphs, ordered graphs, graphs with finitely many edge relations
- $n$ -partite graphs
- hypergraphs
- free amalgamation relational classes omitting 3-irreducible substructures

The following Fraïssé classes have limits satisfying SDAP<sup>+</sup>:

- linear orders (and main reducts) possibly with equivalence relations
- convexly ordered equivalence relations, and variations
- unrestricted relational structures with finitely many relations of any arity (e.g. tournaments)
- Fraïssé classes with SFAP with an additional linear order

## Passing Types and Similarity

Given  $s, t \in \mathbb{S}$  with  $|s| < |t|$ ,  $t \upharpoonright |s|$  is the set of all formulas in  $t \upharpoonright \mathbf{K}_{|s|}$ ,  $t \upharpoonright |s|$  is the **passing type of  $t$  at  $s$** .

Given  $A \subseteq \mathbb{S}$ ,  $t, c_n \in \mathbb{S}$  with  $|c_n| < |t|$ ,  $t(c_n; A)$  denotes the set of those formulas in  $t \upharpoonright |c_n|$  in which all parameters are from among vertices represented by coding nodes in  $A$  with length less than  $|c_n|$ , along with  $v_n$ .

Given  $A, B \subseteq \mathbb{S}$  and  $m, n$ , write  $s(c_m; A) \sim t(c_n; B)$  whenever there is a bijection between the coding nodes in  $A$  of length less than  $|c_m|$  and the coding nodes in  $B$  of length less than  $|c_n|$ , and the order-preserving bijection between those vertices takes  $s(c_m; A)$  to  $t(c_n; B)$ .

**Fact.** If  $A$  and  $B$  have coding nodes  $\langle c_n^A : n < N \rangle$  and  $\langle c_n^B : n < N \rangle$ , and for all  $m < n < N$ ,  $c_n^A(c_m^A; A) \sim c_n^B(c_m^B; B)$ , then the substructures of  $\mathbf{K}$  represented by  $A$  and  $B$  are order-isomorphic.

# Similarity Maps in Coding Trees of 1-types

Let  $S$  and  $T$  be meet-closed subsets of  $\mathbb{S}$ . A function  $f : S \rightarrow T$  is a **similarity map** from  $S$  to  $T$  if for all nodes  $s, t \in \mathbb{S}$ , the following hold:

- 1  $f$  is a bijection which preserves the lexicographic order in  $\mathbb{S}$ .
- 2  $f$  preserves meets, and hence splitting nodes.
- 3  $f$  preserves relative lengths.
- 4  $f$  preserves initial segments.
- 5  $f$  preserves coding nodes and their parameter-free formulas.
- 6  $f$  preserves relative passing types at coding nodes:  
 $s(c_n^S; S) \sim f(s)(c_n^T; T)$ , for each  $n$  such that  $|c_n^S| < |s|$ .

We write  $S \sim T$  whenever there exists a similarity map from  $S$  to  $T$ .



## SDAP<sup>+</sup> implies simply characterized big Ramsey degrees

**Theorem.** (CDP) Suppose  $\mathcal{K}$  is a Fraïssé relational class with finitely many relations satisfying SFAP, or just SDAP<sup>+</sup>. Given  $\mathbf{A} \in \mathcal{K}$ , the big Ramsey degree of  $\mathbf{A}$ ,  $T(\mathbf{A}, \mathbf{K})$ , equals the number of similarity types diagonal antichains of coding nodes in  $\mathbb{S}(\mathbf{K})$  representing a copy of  $\mathbf{A}$ .

**Diagonal antichains** are antichains which have meet-closures with branching degree 2, and such that distinct nodes from among the splitting and coding nodes have distinct lengths.

## SDAP<sup>+</sup> $\implies$ simply characterized BRD: Proof Ideas

- 1 If  $\mathcal{K}$  satisfies SFAP, or just SDAP<sup>+</sup>, then there is a diagonal subtree  $\mathbb{T}$  of  $\mathbb{S}(\mathbf{K})$  which again codes a copy of  $\mathbf{K}$ .
- 2 Do forcing arguments over  $\mathbb{T}$ . Given  $\mathbf{A} \in \mathcal{K}$ , show that  $T(\mathbf{A}, \mathbf{K})$  is bounded above by the number of similarity types of diagonal antichains coding  $\mathbf{A}$ . Note: The forcing just conducts an unbounded search for a finite object - we never pass to a generic extension.
- 3 Take an antichain  $\mathbb{D}$  of coding nodes in  $\mathbb{T}$  which represents a copy of  $\mathbf{K}$ . Prove that for each  $\mathbf{A} \in \mathcal{K}$ , all similarity types of antichains in  $\mathbb{D}$  coding  $\mathbf{A}$  persist in any subset of  $\mathbb{D}$  which again codes a copy of  $\mathbf{K}$ .

**Fun Fact:** This approach bypasses any need for envelopes.

# Fraïssé classes with simply characterized BRD

**Theorem.** (CDP) The following Fraïssé limits have simply characterized big Ramsey degrees, as they satisfy SFAP or SDAP<sup>+</sup>:

- (1)  $\text{Forb}(\mathcal{F})$ , where  $\mathcal{F}$  is a finite set of finite 3-irreducible structures in a finite relational language. *Ex: 3-hypergraphs omitting tetrahedra.*
- (2) Unrestricted Fraïssé classes (generalizing those in (LSV) to higher arities).
- (3)  $n$ -partite graphs, for any  $n \geq 2$ .
- (4)  $\mathbb{Q}$ ,  $\mathbb{Q}_n$ ,  $\mathbb{Q}_{\mathbb{Q}}$ ,  $(\mathbb{Q}_{\mathbb{Q}})_n$ , the main reducts of  $\mathbb{Q}$ .
- (5) Ordered Fraïssé classes satisfying SFAP.

# Ramsey Theory and Topological Dynamics

(Kechris, Pestov, Todorćević 2005) The KPT Correspondence:  
A Fraïssé class  $\mathcal{K}$  has the Ramsey property iff  $\text{Aut}(\text{Flim}(\mathcal{K}))$  is extremely amenable.

(Zucker 2019): If  $\mathbf{K}$  admits a big Ramsey structure, then  $\text{Aut}(\mathbf{K})$  has a metrizable universal completion flow, which is unique up to isomorphism.

(CDP): Any Fraïssé structure satisfying  $\text{SDAP}^+$  admits a big Ramsey structure which is simply characterized by the addition of two more binary relations.

# Fraïssé classes with not-as-simply characterized big Ramsey degrees

## Binary relations and forbidden irreducible substructures

A structure  $\mathbf{F}$  is **irreducible** if any two vertices in  $\mathbf{F}$  are in some  $\mathbf{F}$ -relation.

In (D. 20 and 19\*), upper bounds were found for the  $k$ -clique-free Henson graphs.

In (Zucker 20\*), upper bounds were found for Fraïssé limits of free amalgamation classes with finitely many binary relations and finitely many forbidden irreducible substructures.

**Theorem.** (BCDHKVZ\* 21) Let  $\mathcal{L}$  be a finite binary relational language. Let  $\mathcal{F}$  be a set of finitely many finite irreducible  $\mathcal{L}$ -structures, and let  $\text{Forb}(\mathcal{F})$  be the Fraïssé class of finite  $\mathcal{L}$  structures  $\mathbf{A}$  such that no member of  $\mathcal{F}$  embeds into  $\mathbf{A}$ . Then the big Ramsey degrees of  $\text{Forb}(\mathcal{F})$  are characterized.

## Example: Coding tree for $\mathcal{H}_3$

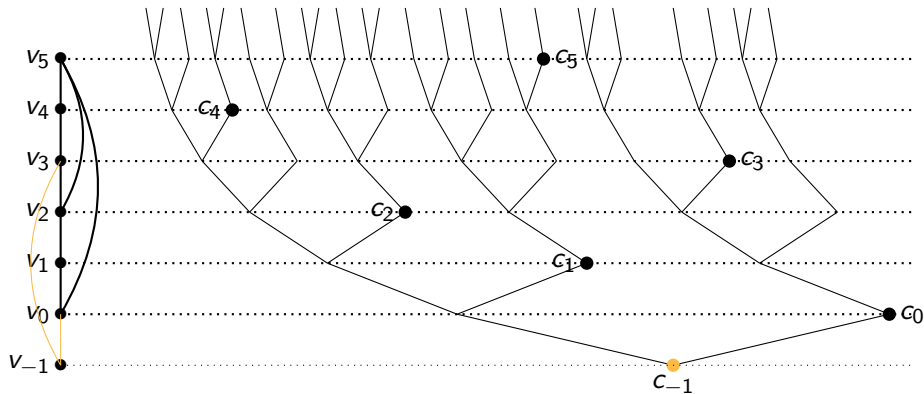

Figure: A coding tree of 1-types  $\mathbb{S}_3$  coding  $\mathcal{H}_3$

## Exact BRD for triangle-free graphs

**Theorem.** (BCDHKVZ\* 21) Let  $\mathbf{A} \in \mathcal{G}_3$  be given. The big Ramsey degree of  $\mathbf{A}$  in  $\mathcal{H}_3$  is the number of ep-similarity types of diagonal antichains of coding nodes in  $\mathbb{S}_3$  representing a copy of  $\mathbf{A}$ .

**ep-similarity** is similarity plus keeping track of age changes due to two nodes coding an edge with a common vertex in  $\mathbf{K}$ .



# Current Methods for BRD, and Future Directions

## Current Methods:

- Milliken's Theorem and variations, (no forcing): (Devlin), (Laflamme, Sauer, Vuksanović), (Laflamme, Nguyen Van Thé, Sauer), (BCHKV).
- Coding trees (using forcing on diagonal subtrees, direct - no envelopes): (D), (CDP).
- Coding trees (using forcing on Milliken-style trees): (Zucker), (BCDHKVZ).
- Category theory: (Barbosa), (Mašulović).
- Parameter words: (Hubička)

## Future directions:

- BRD for free amalgamation classes more generally.
- BRD for strong amalgamation classes more generally.
- Infinite dimensional Ramsey theory: Rado graph done in (D. 2019\*), Structures with SDAP<sup>+</sup> - in preparation (D. 2021\*). Others?

## References

Coulson, Dobrinen, Patel, *Fraïssé classes with simply characterized big Ramsey structures*, (2020) (Submitted).

Recovers results in the following papers:

Balko, Chodounský, Hubička, Konečný, Vena, *Big Ramsey degrees of 3-uniform hypergraphs*, Acta Math. Univ. Comen. (2019).

Devlin, *Some partition theorems for ultrafilters on  $\omega$* , PhD Thesis (1979).

El-Zahar, Sauer, *On the divisibility of homogeneous hypergraphs*, Combinatorica, (1994).

Laflamme, Nguyen Van Thé, Sauer, *Partition properties of the dense local order and a colored version of Milliken's theorem*, Combinatorica (2010).

Laflamme, Sauer, Vuksanovic, *Canonical partitions of universal structures*, Combinatorica (2006).

Pouzet-Sauer, *Edge partitions of the Rado graph*, Combinatorica (1996).

Sauer, *Coloring subgraphs of the Rado graph*, Combinatorica (2006).

## References

Papers on Fraïssé classes with not-so-simply characterized big Ramsey degrees:

Balko, Chodounský, Dobrinen, Hubička, Konečný, Vena, Zucker, *Exact big Ramsey degrees for binary relational free amalgamation structures with forbidden irreducible substructures*, (In preparation).

Dobrinen, *The Ramsey theory of the universal homogeneous triangle-free graph*, JML, (2020).

Dobrinen, *The Ramsey theory of Henson graphs*, (2019) (Submitted).

El-Zahar, Sauer, *The indivisibility of the homogeneous  $K_n$ -free graphs*, J. Combin. Th. Ser. B, (1989).

Hubička, *Big Ramsey degrees using parameter spaces*, (2020) (Submitted).

Komjáth, Rödl, *Coloring of universal graphs*, Graphs and Combin. (1986).

Zucker, *A Note on big Ramsey degrees*, (2020) (Submitted).

Thank you for your kind attention!